

# PureWater



*Das Trinkwasser aus dem Meer*

## Mounting-instruction, User - and maintenance-handbook

for the series NO FRILLS 500-800 STANDARD modular, 230 Volts 50 Hz



NO FRILLS NF 500/800 Standard

PureWater. H. Fehlemann - Desalination

Bodenschwinghstr. 37

33142 Büren Germany

Tel: +49 (0) 2112936944

Fax: +49 (0)2112936945

Mobile: +491713846092

Internet: [www.watermaker.de](http://www.watermaker.de) e-mail: [purewater@watermaker.de](mailto:purewater@watermaker.de)



## **Your Freshwater-Source**

We are happy that you decided in favor of one of our reversion-osmosis-installation (RO unite) and you greet in the growing circle of the users of desalination-installations.

We will do everything in order to satisfy you also after your purchase.

This handbook contains, exact instructions, as you fit in your installation, use it and keep it maintained.

If you should have further questions in addition, you don't hesitate to call us.

In order to gain an optimal performance and a long lifespan of your installation, you read alertly through this handbook before the mounting; if you should require further help, you let it know us.

## Index of contents

System-bases.....	1
Performance data.....	2
Membrane-Performance.....	2
Electric connection-values.....	3
Pressure regulation.....	4
Before mounting. ....	5
Description of the individual parts. ....	6-7
Mounting the pressure vessels. ....	8
Motor and pump. ....	9
Factors affecting Temperature and Pressure.....	10
Flow-diagram. ....	12 +12a
Pressure Regulator.....	13
Electrical installation.....	14
Starting the System.....	15-16
Maintenance.....	16
How to Flush.....	17
Cleaning.....	18
Storage.....	19
Membrane Change.....	20+20a
Manufactures Literature.....	21-23
Logbook.....	24
Quality Monitor.....	25
John Guest System.....	26
Wiring .....	27

## **System-bases**

### **Introduction into the reversion - osmosis**

Reverse-osmosis is a process, with which a membrane divides one water-flow in two water flows. One part is fresh-water and amounts about 7-10 percent of the entire water-quantity, the other flow is concentrated saltwater, which is washed away. Since saltwater is a solution of H<sub>2</sub>O and different solved materials (salt), the membrane acts like a filter. In order to be able to remove these solved materials from the water, the pores of the membrane must be smaller than the solved materials that should be taken away. The pores of a membrane are so small that they can be seen only by one electron microscope. (0,0001 micron), that means, that the sea-water must be pressed through the membrane. This pressure must have the strength of 800 Psi (56 bar) approximately. How high the current pressure must be exact, is a result from the water-temperature and the salt content of the water.

This temperature / pressure-relationship later will be explained later in this handbook.

See chapters: Temperature - Pressure - Correction.

As you know, each filter can become blocked or damaged. A reverse-osmosis-membrane is no exception. Your System is designed that surplus particles are rinsed with the Brine flow.

Nevertheless, there are conditions, which contaminates, blocked or damage the membrane. With regular maintenance, as it is described in this handbook, the possibility of a failure of a membrane can be minimized and costly substitute be avoided. Regular maintenance is comparatively affordable, gets the effectiveness and extends the lifespan of the installations.

## Performance Data

### Membrane-performance\*

Model	gallons per hour	liter per hour
200 GPD	8,30 GPH	31,41 LPS
400 GPD	16,60 GPH	62,83 LPS
500 GPD	20,80 GPH	78,20 LPS
<b>600 GPD</b>	<b>25,00 GPH</b>	<b>94,50 LPS</b>
<b>800 GPD</b>	<b>38,00 GPH</b>	<b>145,00 LPS</b>
<b>1000 GPD</b>	<b>52,90 GPH</b>	<b>200,00 LPS</b>
1300 GPD	54,20 GPH	205,14 LPS
1800 GPD	75,00 GPH	283,81 LPS
2000 GPD	83,33 GPH	315,40 LPS
3000 GPD	125,00 GPH	473,12 LPS

Salt-Rejection = Minim. 99,2%

Water-quality = above WHO standard

•Sea-water-temperature, pressure and salt content have strong influence on the performance and quality of the product-water. Details you find in the chapter Operation.

### Test-conditions

Pressure	800 PSI
Sea-water-temperature	25° C
Salinity	35,000 PPM (parts of million))

### Pump-performance

Operating-pressure	700 - 1000 PSI
--------------------	----------------

### Total flow

200-800 GPD systems	2.90 GPM
1000-1800 GPD systems	3.7/4.76 GPM

## NO FRILLS 500/800 guides

---

### Electric connection-values

#### 230-volt

SERIES	Ampere	KILOWATT
NO FRILLS 500/600 GPD	9,5	1,5
NO FRILLS 800/900 GPD	9,5	1,5
NO FRILLS 1000-1800 GPD	16	1,85/2,2

### Electric wiring

The connection should be carried out by a qualified electrician.

#### Control box:

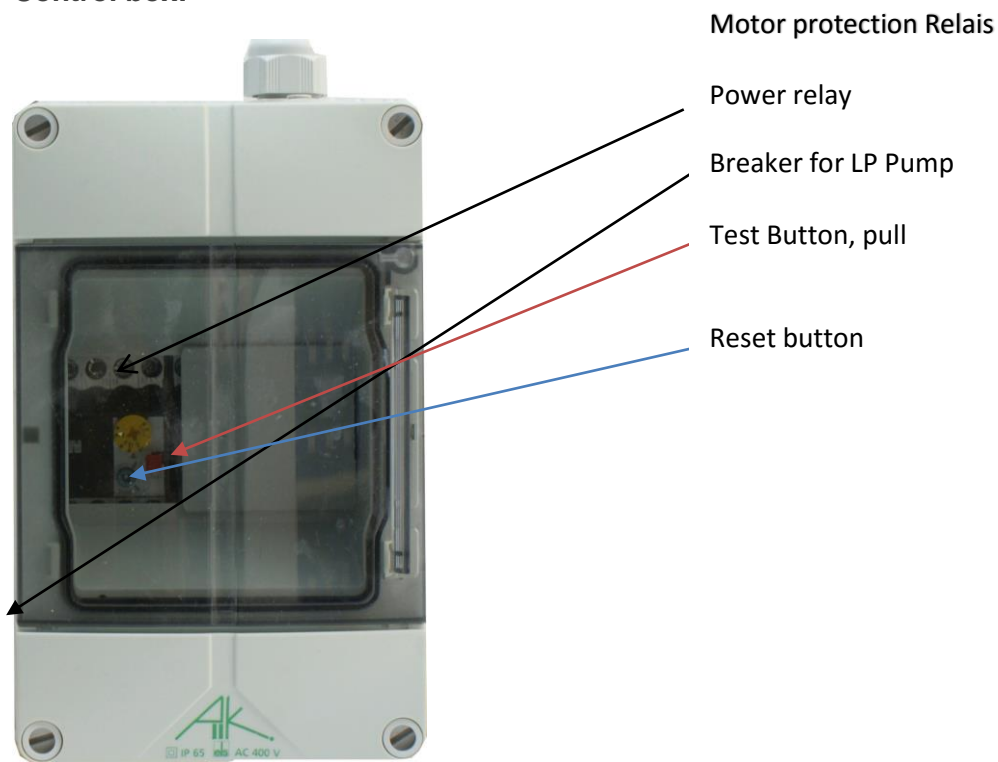

### Motor connection for CAT Pumps

See attached CD. For Identification of the wires at the pump, we left a short piece of wire out of the box at the motor. However, you are free to connect the wires inside the box. The build in switch is not needed. If you leave the switch, make sure, it is in the ON position.

**Electrical connections should be done by a qualified electrician.**

**Cable Identification: NO 1 = L NO 2= N or Blue=N Brown= L Yellow green=GN**

## NO FRILLS 500/800 Guides

The NO FRILLS 500/800 modular COMFORT is delivered in following implementation.

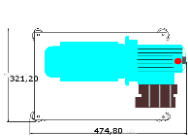

Motor and HP Pump

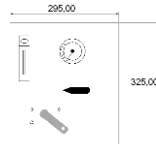

Main Controlpanel

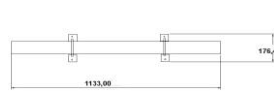

Pressure Vessel and Membrane

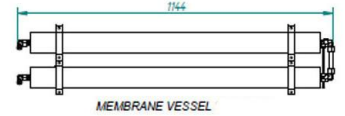

NF 500/800

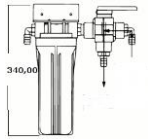

Fresh Water flush system

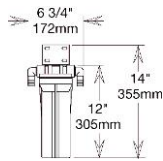

Pre-Filter NF 500

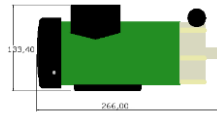

LP Pump



Pre-Filter NF800

## Pressure Regulation and Flow distribution

Quality Monitor

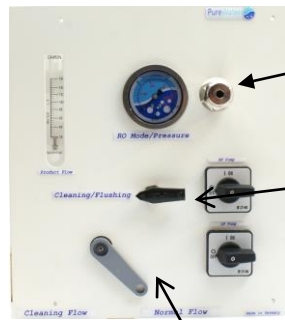

Pressure Regulator  
Pressure indicator

High Pressure Bypass Valve  
Position: No pressure, cleaning  
flushing

CLEANING VALVE: Position: NORMAL FLOW: for desalination and flushing. **Brine Flow over board.**

Position: CLEANING: for cleaning and preservation. The flow is returned to the LP PUMP or to the "T" at the pre filter. See flow diagram.

### **Before mounting!!**

Please pay attention to the following points before you fit in your NO FRILLS installation and take in operation!

1. The unit should be taken in operation within 12 months after delivery
2. The unit should about every 7 days, in very hot areas, every 3 days, operated with sea water or flushed with fresh-water.
3. If the unit is for a long time out of order, it should at the latest after 12 months flushed and preserved again.
4. Never operate the system in harbors or in areas where fuel and oil is in the sea-water.
5. If you use the system in fresh - or brackish water, the operating-pressure must be adjusted, that the output of fresh water is within the operating limits.
6. Protect the installation from freezing.
7. Don't let the membrane dry out. If you take out the membrane for any reason, it has to be sealed immediately.
8. The sea-water- inlet must be shaped so that the sea-water is pressed in during cruise.

### **Attention!!**

The quantity of the produced drinking water is very strong dependent on the temperature of the sea-water. All accomplishment-statements are based on a temperature of the sea-water of 25°C. Per 1°C below 25°C, the production loses 3 percent of performance.

As well, the salinity of the sea water is a factor. Higher salinity, lower performance.



### **The general scopes of the NO FRILLS desalination-installations**

The NO FRILLS RO systems are laid out according to the last realizations of the revers-osmosis-technology. These installations enjoy ever more severe popularity with Cruisers, sport-fishers and on boats, where mounting space is limited.

The NO FRILLS systems are simple to use and uncomplicated in maintenance.

The NF 500 produces about. 85 liters / h, the NF 800 produces, about. 150 liters / h. See the reduced performance with temperatures below 25°C.

### **2.2 descriptions of the individual parts**

#### **The 230 V boost-pump. (LP Pump)**

The boost-pump is required to the circulating the sea-water if the high-pressure-pump is built-in at or above the waterline. The booster-pump must be installed below the waterline. The booster-pump supports the start-process, trapped air is fast removed.

#### **Hand-water-test-appliance (Optional) N.A. on COMFORT and COMPACT Models**

The hand-water-Tester measures how much ppm of the TDS still is in the water. The value from the World-Health-Organization, WHO, for good drinking water, is 500 ppm.

ppm = parts per million TDS (total dissolved Solids)

#### **Pressure gauges**

The pressure gauge shows how much pressure the high pressure-pump delivers. The work-area is between 800 and 950 psi.

#### **High pressure-pump**

The high pressure-pump pumps waters through the membrane

#### **Flow meter**

How much drinking water is produced in the hour shows the flow-meter.  
(In U.S. gallons per hour) 1 U.S. Gallon = 3.78 liters. From 2016 in L/h

#### **Pressure Regulator**

The pressure control allows the operator to regulate the pressure. 800 psi is normal.

#### **Sea-water-filters (option) for BASIC and STANDARD**

The sea-water-filter keeps back coarse particles and spares the booster-pump and the pre-filter consequently.

#### **Pre-filter**

The pre-filter has a permeability of 20/5 microns and filters the fine particles.

#### **Sample Valve (option) N. A. for COMFORT and COMPACT Models**

The sample-valve enables to take a water-test directly at the exit of the system. This is to the control the water quality so that one can prevent the influx of bad water.

**Cleaning-valve** (mounted at the pressure regulation)

This valve enables, either a flow over board (Normal Flow), or a recirculation for cleaning and preservation.(Cleaning Flow) See flow diagram.

**Fresh-water – flush system (FWS)**

The fresh-water – flush system provides flushing the system when not in use, with fresh water, just with a turn of the handle at the selector valve. The build in changeable carbon filter cartridge prevents that chloride exits the membrane. The handle must be installed below the waterline if you install the system acc. Page 12. When installing acc. Page 12a all components except the boost pump can be mounted over the waterline. Flushing the system extends the lifetime of the membrane and is used for short time storage. (up to 10 days)

**POS: Desalination**

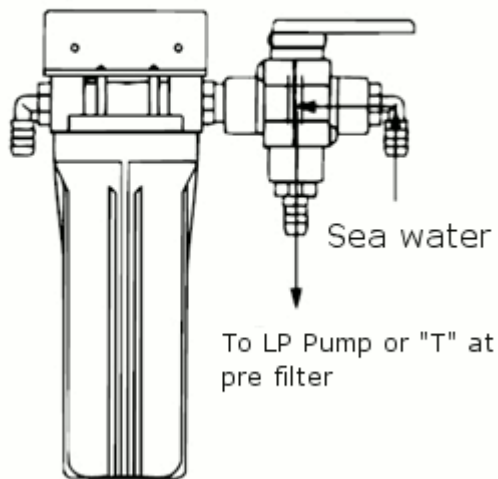

**POS: Fresh water flush**

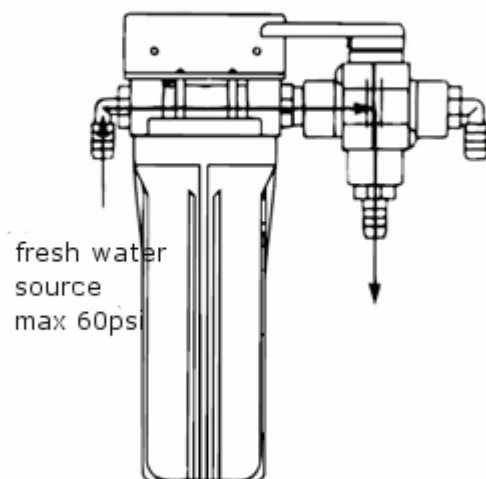

## Mounting the pressure vessels

The pressure vessels are individually packed and have to be mounted on the brackets.

From January 1<sup>st</sup> the Membranes are ready mounted.

All PV (pressure vessels) are marked with an arrow – feed flow direction -.

The PV's are marked also with PV 1 and PV 2.

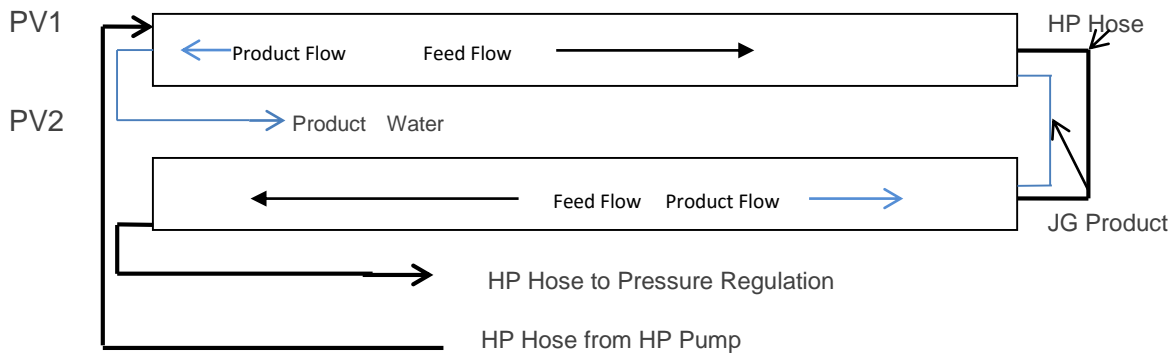

Connect the high pressure hose from the HP pump with PV 1, where the yellow spot is located.( only Phoenix vessels ) On Super Duplex Vessels there is a Mark PV1

Connect the high pressure hose from the pressure regulation to PV 2, there is **no** yellow spot located, but a mark PV2.

Connect the short HP hose, delivered in a plastic bag, to the both right HP hose connections at PV 1 and PV 2. See picture above.

Last step is to connect the fresh water hose assy to the both 1/4" hose barbs or John Guest connections at the PV, right side. How to use the John Guest connections you find at the end of this manual.

### NOTE!!

All high pressure connections have seals. Don't tighten the connections to strong, this could damage the seal. Just a little click with the key is enough.

## Motor and HP Pump

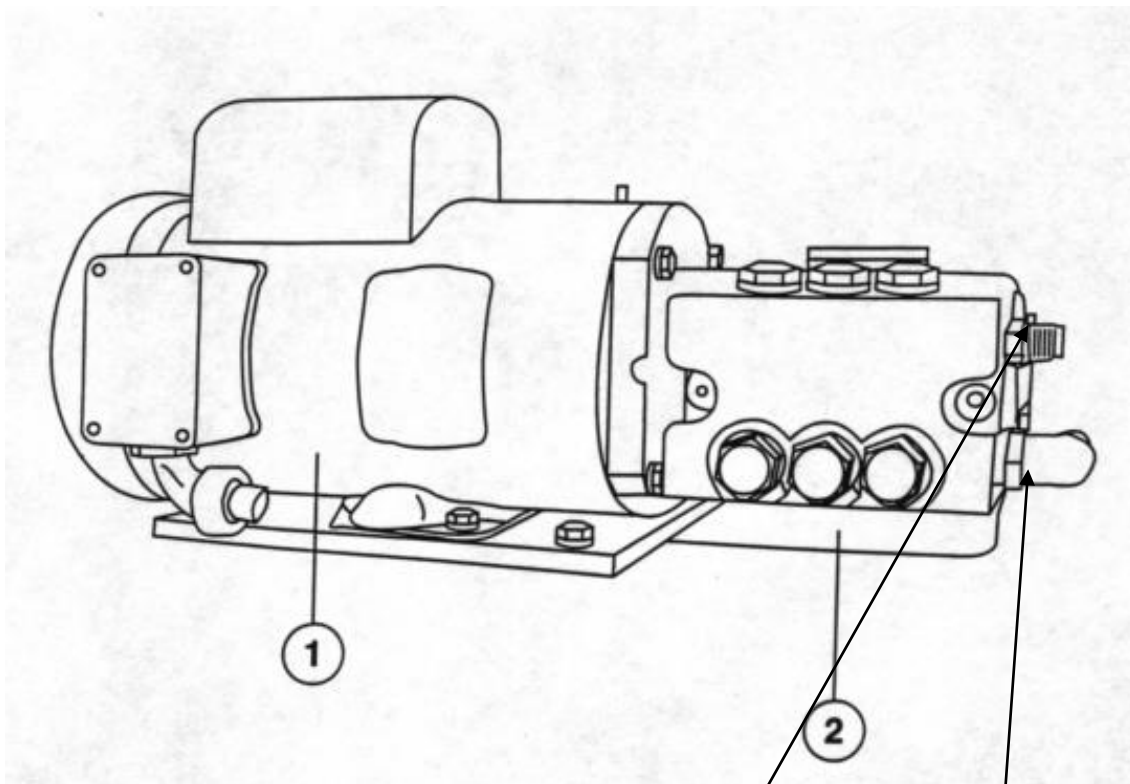

1 Motor

See water inlet

High pressure connection

2 High pressure pump

**Attention: Before starting the Pump, change the red safety transportation cap to the yellow cap with the mark: OIL. This will provide crank shaft ventilation.**

**For CAT Pumps remove the tape over the red oil filler cap. The Oil could be removed for transportation by air. Check if oil is in the pump!!!! Recommended is normal non-synthetic 15W40 oil.**

## FACTORS AFFECTING PERMEATE PRODUCTION VARIATIONS IN TEMPERATURE, PRESSURE, AND SALINITY

The following table illustrates how the quality and quantity of permeate produced by a RO system is affected by changes in temperature, salinity and pressure:

With constant	and increasing	TDS	Capacity
Salinity and pressure	Temperature	increasing	increasing
Temperature and pressure	Salinity	increases	decreases
Temperature and salinity	Pressure	decreases	increases

\* If the feed water salt concentration decreases, the product water flow rate should not be allowed to increase more than 20% above rated flow. Feed pressure may need to be lowered to maintain rated flow in brackish water or tap water applications.

\*\* Feed pressure shall not be increased above 950 psi.

The RO system can be adjusted to maintain a constant permeate output when feed water temperature and salinity is other than nominal. The operator can do this by controlling system pressure manually via the backpressure regulation valve located in the system brine piping. As permeate flow decreases, the operator can throttle the pressure regulation valve closed to increase system pressure. This, in turn, will increase the permeate output and mitigate the effect of a decrease in temperature or an increase in salinity. Conversely, the operator can open the pressure regulation valve to reduce pressure and permeate flow in areas of excessively high temperature or low salinity.

**IN FRESH OR BRACKISH FEEDWATER CONDITIONS, MAKE SURE TO REDUCE PRESSURE BY TURNING REGULATOR. SET PRESSURE SO, THAT PRODUCT FLOW IS NO MORE THAN 120% OF DESIGNED FLOW; TO PREVENT MEMBRANE DAMAGE.**

### TEMPERATURE CORRECTION FACTOR

As previously described, the output capacity of any RO unit is highly dependent on feed water temperature. In order to quantify this relationship, operational data has been utilized to develop Temperature Correction Factors (TCF). The TCF (which is compensated to 25°C/77°F) is used to determine what part of any change in system output flow is due to variations in feed water temperature alone. This, in turn, allows the operator to establish the baseline flow for a given temperature, allowing more accurate troubleshooting. The procedure for calculating the TCF and the temperature compensated flow is as follows:

- 1) Measure raw water temperature.
- 2) Determine the corresponding correction factor from Table 3.2 based on the measured temperature.
- 3) Note the product flow rate at the Product Flow meter.
- 4) Multiply the measure (uncorrected) product flow meter flow rate by the correction factor from Table.

## NO FRILLS 500/800 Guide

---

### Example:

Raw water temp: 15°C

TCF: 1.47

Uncorrected product flow: 12.75 (gph)

Calculation:  $12.75 \times 1.47 = 18.743$  (gph)

Corrected product flow: 18.7 (gph) This is the normal flow for a NF500

°C	Factor	°C	Factor	°F	Factor	°F	Factor
1	3.64	26	0.97	34	3.47	84	0.88
2	3.23	26	0.94	36	3.18	86	0.82
3	3.03	28	0.91	38	3.18	88	0.79
4	2.78	29	0.88	40	2.68	90	0.79
5	2.58	30	0.85	42	2.47	92	0.77
6	2.38	31	0.83	44	2.29	94	0.75
7	2.22	32	0.80	46	2.14	96	0.73
8	2.11	33	0.77	48	2.01	98	0.70
9	2.00	34	0.75	50	1.88	100	0.68
10	1.89	35	0.73	52	1.77	102	0.65
11	1.78	36	0.71	54	1.68	104	0.63
12	1.68	37	0.69	56	1.59	106	0.61
13	1.61	38	0.67	58	1.51	108	0.59
14	1.54	39	0.65	60	1.44	110	0.57
15	1.47	40	0.63	62	1.36	112	0.55
16	1.39	41	0.61	64	1.30	114	0.53
17	1.34	42	0.60	66	1.24	116	0.51
18	1.29	43	0.58	68	1.17	118	0.49
19	1.24	44	0.56	70	1.12	120	0.47
20	1.19	45	0.54	72	1.08	122	0.45
21	1.15	46	0.53	74	1.05		
22	1.11	47	0.51	76	1.02		
23	1.08	48	0.49	78	1.00		
24	1.04	49	0.47	80	0.93		
25	1.00	50	0.46	82	0.90		

(

Flow diagram (Installation above Waterline)

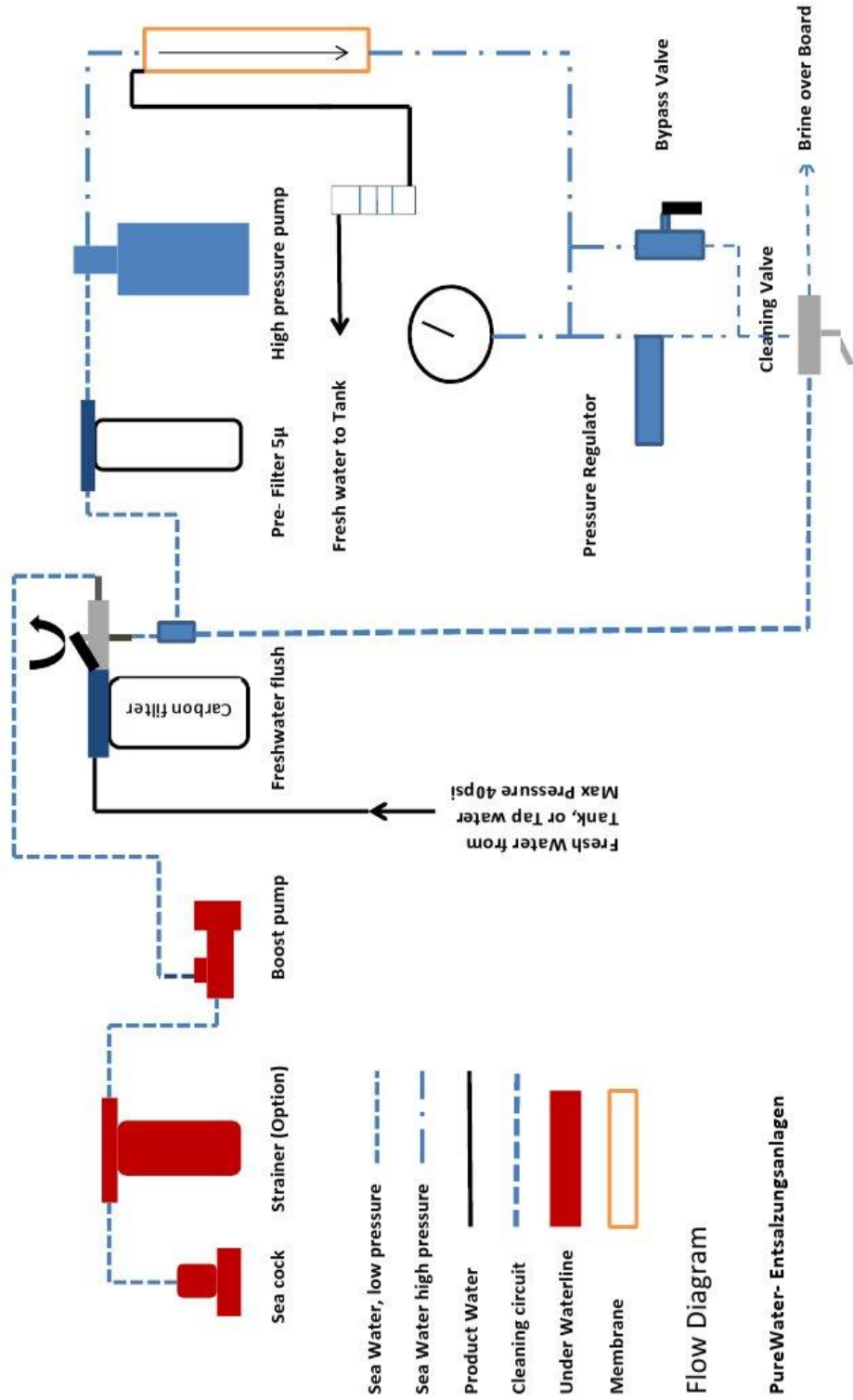

Flow Diagram (Installation below Waterline)

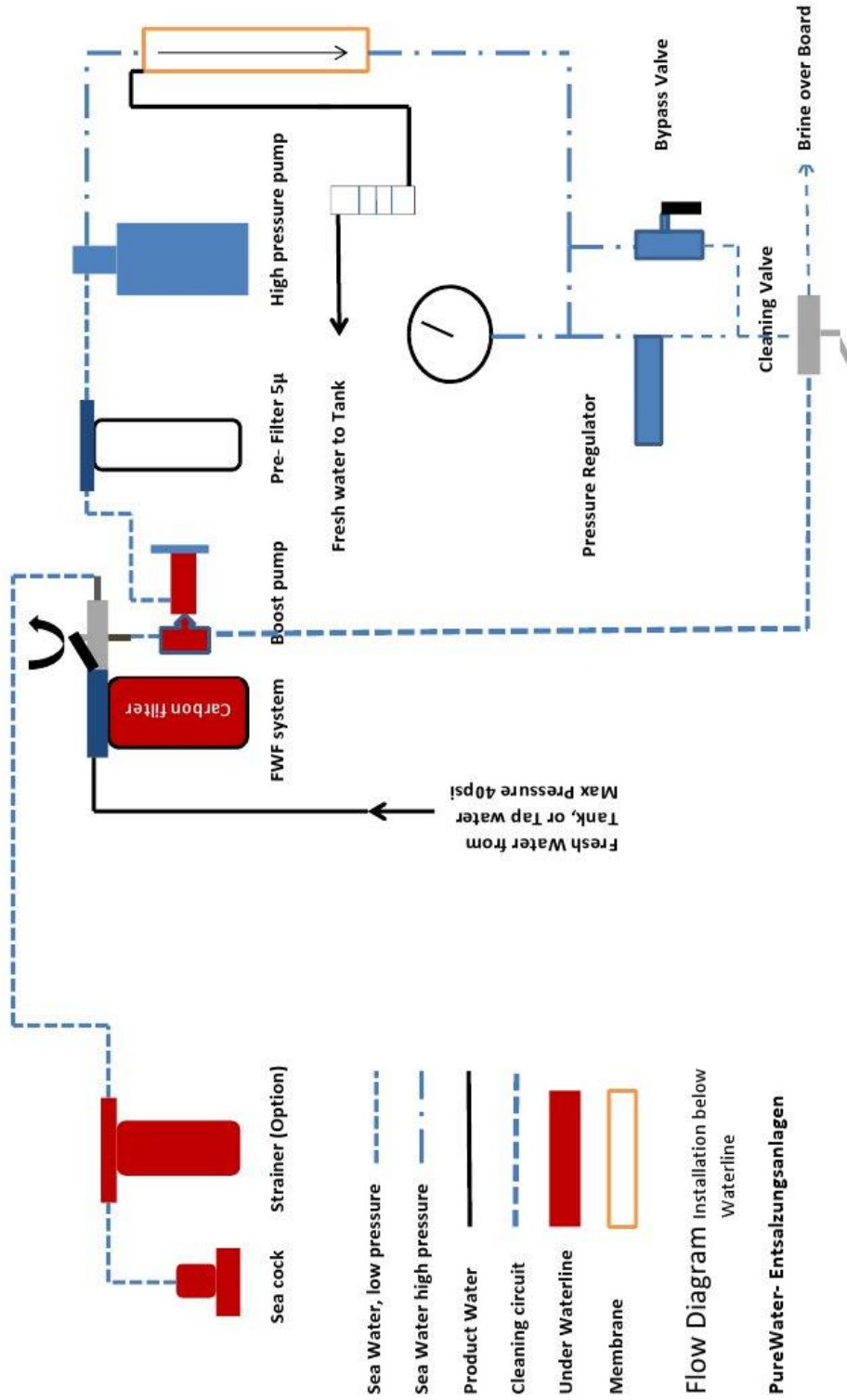



### Mounting and connections

On the picture below, you see pressure regulator, looking from the top. This could be adjusted with a 27mm key. **From 2016 the pressure regulator is mounted through the panel to the front.**

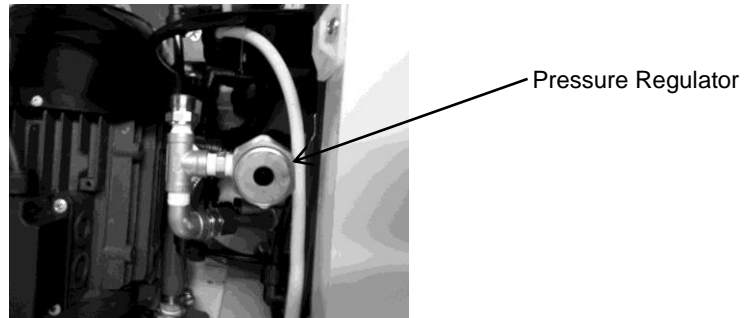

### Pressure Regulator

The pressure regulator is a fixed set up type; however, it can be adjusted. The regulator is factory set to 800-820psi (56bar). It might be necessary to adjust. That depends on salinity and temperature. Refer to Temperature and salinity adjustment. But anyhow, the unit will operate with 800psi pressure within the operational limits.

#### Mounting the system:

Find good positions for the components. Motor and Pumps should be in a dry place. Accessible parts are the pressure regulation, the pre-filters and the fresh water flush system. Keep a little space below the filters for changing the filter elements. Install a seacock in the feed water line.

Mount the system according to the flow diagram. All sea water lines are  $\frac{3}{4}$ " hoses. Don't use transparent hoses. All freshwater hoses are  $\frac{3}{8}$ " or  $\frac{1}{2}$ " We recommend hose qualities which have drinking water grade. The LP pump and the fresh water flush system have to be placed under the waterline. **With the installation on Page 12a you can place all parts, which are not marked red, over the waterline.** But the most used installation is according Page 12.

## **TO CONNECT THE ELECTRICAL**

**TURN OFF ALL ELECTRICAL POWER FOR USE WITH THE RO UNIT PRIOR TO CONNECTING TO THE RO POWER SOURCE. FAILURE TO DO SO MAY RESULT IN SERIOUS INJURY OR DEATH TO PERSONS HANDLING THE UNIT.**

**NOTE:** Adhere to all electrical codes and regulations governing the installation and wiring of electrical equipment. Typical codes specify the type and size of conduit, wire diameter, and class or wire insulation depending upon the amperage and environment.

**NOTE:** The power supply should always be of greater service rating than the requirements of the RO unit. This will assure proper voltage even if power supply voltage is slightly less than required.

**Never connect the RO unit to a line that services another electrical device.  
THE RO UNIT SHOULD HAVE ITS OWN INDEPENDENT POWER SUPPLY.**

**NOTE:** We recommend use of a **15 amp** fuse or circuit breaker for **230 Volts AC** units.

**Cable Identification: No.1= L , No.2 = N or blue=N , brown= L , yellow/green= GND**

**Control cable from the control box to the switches at the panel – Version Standard.**

Cable identification: 1 = Positive 12V, 2 = HP Pump, 3 = LP Pump

## **Starting the System**

Step 1: Verify all power switches and power sources are in the **OFF** position.

Step 2: Turn the High Pressure Bypass Valve (Black Valve) to **CLEANING/FLUSHING** Position. This procedure allows release of the high pressure air trapped within the system.

Verify the Cleaning Valve (Grey Valve) is positioned to **NORMAL FLOW** discharge. Also check the grey Freshwater Flush Valve is positioned for seawater intake, **NOT** freshwater.

**FAILURE TO OPEN THE HIGH PRESSURE BYPASS VALVE, WHICH IS REQUIRED TO RELEASE ANY TRAPPED AIR, COULD RESULT IN HYDRAULIC SHOCK TO THE SYSTEM.**

Step 3: Verify the seawater intake is open at the through-hull. This allows the feed seawater to flow into the unit.

Start-up time can be expedited by filling the pre-filter housing with non-chlorinated freshwater, before the RO unit is turned on.

Step 4: Switch **ON** the breaker at main breaker panel to power up unit.

Step 5: Upon start-up inspect all plumbing connections in the unit for leakage. Varying temperatures during shipment may cause plumbing connections to seep when starting the RO unit for the first time. Secure the unit and repair any leaks before proceeding. Once the leaks are repaired, open the raw water source and restart the unit.

Step 6: Observe the Brine Flow over board, to ensure all air and bubbles exited the RO system before proceeding to next step.

Step 7: Gradually turn the High Pressure Bypass Valve (Black Valve) to **RO MODE/ PRESSURE** position. The pressure gauge should steadily rise to a reading of 800-820 psi.

Step 8: Observe the system pressure on the High Pressure Gauge. During RO production, the indicated pressure should be at 800-850 psi (depending on Seawater temperature) If the pressure reading is not at 800-850 psi, adjust the pressure regulator.

**NOTE: If the RO unit is used for other than seawater purification (in freshwater or brackish water applications), reduce pressure as necessary to achieve product flow no greater than 120% of design flow to avoid membrane damage.**

**RO pressure production should NEVER EXCEED 950 psi, doing so risks damage to RO unit which would VOID factory warranty.**

Step 9: Taste the water quality or test it with a hand-held test meter to determine water quality. If quality is good allow the water to flow into the Tank. N.a. for COMFORT and COMPACT systems there is a controller and you can read the quality.

Step 10: Check the RO unit for water leakage periodically at the initial start-up. Observe Product Flow meter.

Record the product flow after 48 hours of operation (use the sample log sheet provided).

### **4.2 TO SHUT DOWN UNIT**

Step 1: As the RO unit operates, turn the High Pressure Bypass Valve (Black Valve) to **CLEANING/FLUSHING** Position. (Counter clockwise), when RO unit is running. This will release the high pressure within the RO system.

Step 2: Turn **OFF** your power at the control box.

The RO unit may be left in this “stand by” condition with the seawater for up to seven days or three days in hot, tropical climates. If the RO unit will be out of service for extended time periods, please refer to the Maintenance section of this manual.

## MAINTENANCE

The service life of most system equipment is directly related to the raw water inlet conditions. Improper maintenance will also significantly reduce the life expectancy of the major unit components (such as the membranes, filters and pumps) as well as the reliability of the unit as a whole. Under normal conditions, and with proper maintenance, a reverse osmosis membrane (which is the major consumable item) should have an effective service life somewhere between 4 and 6 years.

**NOTE: The RO unit must be cleaned when product water output drops by 20%.**

**Table 5.1: Maintenance Task Chart.**

	Daily	Weekly	Monthly	Quarterly	Semi-Annually	Annually	As Required	Labor Hours (approximate)
Clean/inspect micron prefilter			•					0.5
Replace filter(s)*				•				0.5
Clean membranes							•	2.0
Replace Membranes							•	1.0
Check pump oil level			•					0.1
Change pump oil**						•		0.5

 Table 5.1: Maintenance Task Chart.

\*\* Change pump oil after first **100** hours of RO use. After the first oil change at 100 hours, change the pump oil every **500** hours thereafter or once annually which ever interval comes first.

## FRESHWATER FLUSH / SHORT TERM STORAGE

Ideally, the No Frills performs optimally when the RO unit is used regularly. The likelihood of bacterial and biological growth in the membranes increases, when stagnant seawater (in extended periods) is in contact with the membranes. A freshwater flush procedure is necessary to prevent clogging and growth of organic contaminants in the RO system and its membranes. This method pushes out older stagnant seawater (saltwater) out of the membranes and replacing it with freshwater (non-saltwater), leaving less chance of fouling the membranes. The freshwater flush procedure should be used when the unit will be placed idle or in “stand by” condition for more than several days **OR** idle for three days in hot, tropical climates. Although they do not attack the membranes or other system components directly, high concentrations of biological matter can block enough of the product water channels to cause a reduction of as much as 40% of the total system capacity.

**PERFORM A FRESHWATER FLUSH TO THE RO UNIT WITH NON-CHLORINATED FRESH WATER ONLY. EXPOSING THE MEMBRANES TO CHLORINATED WATER WILL CAUSE IRREVERSIBLE DAMAGE AND VOID THE RO UNIT WARRANTY. THE FRESHWATER FLUSH SYSTEM USES A CARBON FILTER INLINE BEFORE SYSTEM TO CONSUME THE CHLORINE THAT MAY BE PRESENT FROM THE DOCK WATER.**

## **TO FLUSH THE *NO FRILLS* UNIT**

- Step 1: Verify all power switches and power sources are turned **OFF**.
- Step 2: Turn **ON** your water pressure and watermaker breakers on main electrical panel.  
Turn the High Pressure Bypass Valve to **CLEANING/FLUSHING** (ensuring zero pressure in system). Verify the gray Cleaning Valve is positioned to **NORMAL FLOW** position.
- Step 3: Turn the gray Freshwater Flush Valve to **FRESHWATER** position.
- Step 4: Turn the switch at the control panel to **ON (HP pump only)**
- Step 5: Verify the freshwater supply pressure does not exceed 35 psi.
- Step 6: After flushing the unit for 7 minutes, turn the switch at the control panel to **OFF**.
- Step 7: Turn the gray Freshwater Flush Valve to **SEAWATER** position. Leave RO unit in standing condition, for up to three Month. Then re-flush or preserve.
- Step 8: To restart the **NO FRILLS**, refer to instructions: **TO START THE NO FRILLS UNIT**.

## **CHEMICAL CLEANING PROCEDURE**

The RO unit must be chemically cleaned when product water output drops below 80% of original production. The frequency of this occurring will vary greatly upon feed water. Fouling odor from the membrane will naturally occur during regular usage of the RO unit. The fouling odor will progress without proper cleaning of the membranes, therefore reducing the efficiency of the RO unit.

**THE USE OF CHEMICALS OR CLEANING METHODS OTHER THAN THOSE OUTLINED IN THIS MANUAL WILL VOID THE RO UNIT WARRANTY. NON-IONIC SURFACTANTS USED FOR MEMBRANE CLEANING OR ANY OTHER CHEMICALS NOT APPROVED IN WRITING BY PUREWATER, WILL VOID THE RO UNIT WARRANTY.**

**CLEANING CHEMICAL #1 IS AN ALKALINE DETERGENT, USED TO REMOVE OIL, GREASE, BIOLOGICAL MATTER, AND GRIME FROM THE SURFACE OF THE RO MEMBRANES. SEE WARNING LABEL ON SIDE OF PACKAGE AND OBSERVE ALL SAFETY PRECAUTIONS ON LABEL.**

**CLEANING CHEMICAL #2 IS AN ACID, A MINERAL SCALE REMOVER. SEE WARNING LABEL ON SIDE OF PACKAGE AND OBSERVE ALL SAFETY PRECAUTIONS ON LABEL.**

**NOTE: All cleaning and preservation procedures can be done with either NON-CHLORINATED freshwater to optimize performance of cleaning process, or see water.**  
**NOTE: You should allow your unit's product water to run and drain for the first 30 minutes after cleaning or upon start up after preservation.**

## **CLEANING STEPS FOR CHEMICAL #1 AND #2**

### **Single Use Cleaning Cartridges**

Step1. Prior cleaning the RO perform a fresh water flush to the system. Turn the handle at the freshwater flush system to SEA WATER operation to stop the fresh water flow.

Step2. Remove the 5 micron filter from housing

Step3. Place cleaning filter #1, blue stripe, into filter housing and close it.

Step4. Place High Pressure Bypass valve in cleaning pos.

Step5. Turn Cleaning Valve in Cleaning Pos.

Step6. Start the RO Unite an let it run for 30 Min.

Step7. Stop the RO system and turn the cleaning valve to NORMAL FLOW. Then flush the system with fresh water.

Step8. Place the Cleaning Filter#2, red ring, into the filter housing and start with Step4 to Step7.

Step9. Place a new 5 micron Filter into the housing.

### **Powder Form**

Step1. Prior cleaning the RO perform a fresh water flush to the system. Turn the handle at the freshwater flush system to SEA WATER operation to stop the fresh water flow.

Step 2. Place 6 TBSP of #1 into the filter housing and fill with clean water.

Step3. Crystals need to be completely dissolved before proceeding to next step. Screw housing back into place.

Step4. Place High Press. Bypass in Cleaning pos.

Step5. Turn Cleaning valve into cleaning.

Step6. Start the RO Unite and let it run for 30 Min.

Step7. . Stop the RO system and turn the cleaning valve to NORMAL FLOW. Then flush the system with fresh water.

Step8. Place 4 TBSP of chemical#2 into the filter housing and repeat the Step3 to Step7.

## LONG TERM STORAGE / PRESERVATION PROCEDURE

During periods when the RO unit is to be shut down for an extended period of time, it is necessary to re-flush the unit every two Month, OR to circulate a preservative solution through the membrane to prevent the growth of biological organisms. Use the following procedure to preserve the RO elements:

**PRESERVATIVE CHEMICAL #3 IS A FOOD GRADE PRESERVATIVE. SEE WARNING LABEL ON SIDE OF PACKAGE AND ADHERE TO ALL SAFETY PRECAUTIONS ON LABEL.**

**NOTE: You should allow your unit's product water to run to drain for the first 30 minutes after cleaning or upon start up after preservation.**

The procedure is the same than cleaning Step 1 to Step 6. Step 7 is to remove the cleaning filter and leave everything as it is until using the RO system again. Use either Cartridge or powder for preservation. Use 3 TBS of powder.

## OIL CHANGE PROCEDURE

An oil change is recommended after the first 100 hours of RO use. Subsequent oil changes are to be performed every 500-hour intervals OR changed annually. Change oil any time moisture is detected or if oil is cloudy. For additional pump information, refer to

### **MANUFACTURER'S LITERATURE**

at the back of this manual. Or CAT Pumps CD.

**NOTE: The first oil change requires a complete oil drain, to ensure your pump is free of any fragments.**

**DO NOT RUN PUMP WITHOUT OIL IN THE CRANKCASE.**

**NOTE: Prior to the oil change, it MAY facilitate the oil replacement process by running the RO unit to heat the oil. Heating the oil reduces the viscosity allowing it to be more fluid to travel through the pump.**

## Change of Membranes

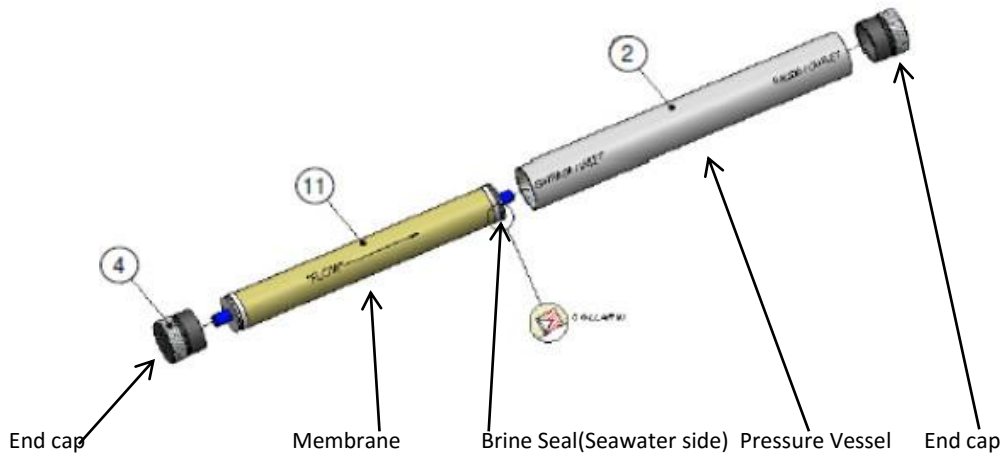

To change the membrane, start on the side, where the sea water is going into the membrane. This is normally the side, where the yellow spot on the PV is located. (Only Phoenix). On PW Vessels, the super Duplex type, locate the feed flow Arrow. At the beginning of the arrow is the seawater side. On this Pressure Vessel Types the Brine Seal is at the opposite side, the side at the feed flow arrow. Turn out the End cap at this side by using a key. Then you can take out the Membrane. The Brine Seal is in the End Cap. When unpacking the new Membrane it is necessary to change the Seal at the new Membrane from the original side to the other side and the seal has to be turned, that the lip of the seal is down. Carefully put the End Cap over the Brine Seal of the new Membrane.

Before installing the new membrane, lubricate everything with SILICON GREASE or Glycerine. Don't use any other lubricant. Any other lubricant will damage the membrane.

Push the new membrane into the PV and push the end cap in position.

### PW Super Duplex Pressure Vessels

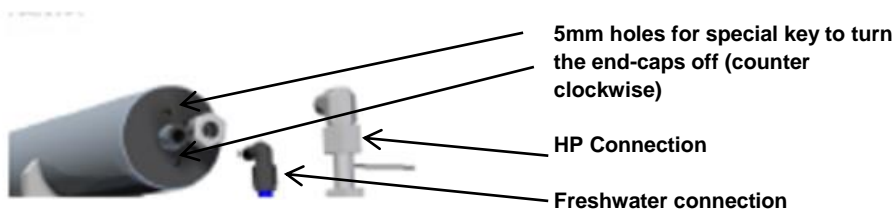



## Endkappen bei Phoenix Druckgehäusen

### Endcaps with Phoenix pressure vessels

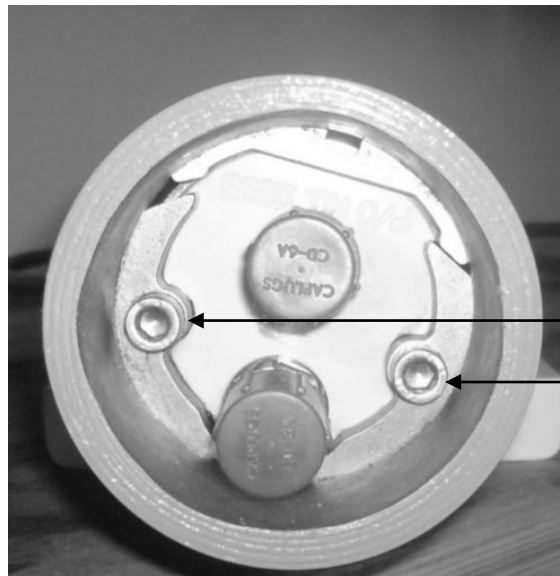

5mm  
Inbus/Allen

Die Phoenix Druckgehäuse unterscheiden sich von den AQUA PRO Gehäusen nur durch die Farbe und die Endkappen.

Zum Wechsel der Membran lösen Sie die beiden Inbusschrauben. Sie können dann die Befestigungen herausnehmen. Legen Sie diese so auf eine Arbeitsplatte, wie Sie diese herausgenommen haben. Das erleichtert den Einbau später. Ziehen Sie dann die Kunststoffendkappe mit einer Zange, die Sie am Anschluss für den Hochdruckschlauch ansetzen, hinaus. Fetten Sie die Dichtung **mit Silikonfett**. Dann können Sie die Membran herausziehen. Setzen Sie die neue Membran in der gleichen Richtung wieder ein. Achten Sie darauf, dass der Dichtungsring an der Membran an der gleichen Stelle ist. Er muss immer an der Seite des Gehäuses sein, wo das Seewasser eintritt. Drücken Sie dann die Kunststoffendkappe wieder in das Gehäuse hinein und setzen Sie die Sicherungsbolzen wieder ein. Sichern Sie diese wieder mit den beiden Inbusschrauben.

#### To Change the Membrane:

Loose the two 5 mm Allen screws, take the three fasteners out. Pull the plastic endcap out (use two screw drivers). Then pull the membrane out. Insert the new membrane. The black seal must be at the side, where the yellow spot is located on the pressure vessel. **Use only silicon grease**. Then press the endcap back into the pressure vessel and install the fasteners the same way, you took them out.

Manufactures Literature (For Interpump – CAT Pumps will have an attached CD)





**INTERPUMP GROUP**  
INTERNATIONAL TECHNICAL COMPANY

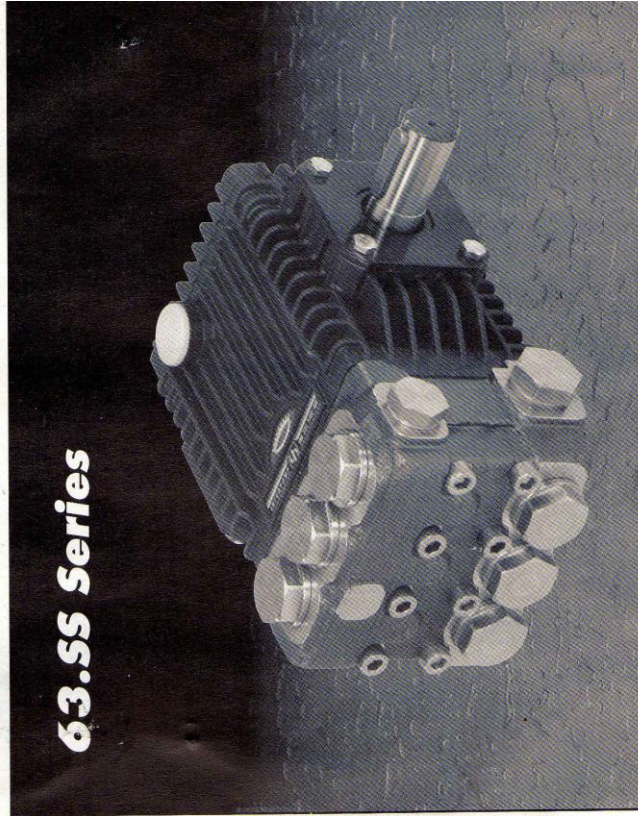

Pump type	Volume Leistung Debit Caudal Portata		Pressure Druck Pressione Pressione		r.p.m. u.p.m. t/min. g/min.	Required Leistung Puissance Potencia Potenza Hp / kW	Weight Poids Gewicht Peso kg
	l/min	G.P.M. (USA)	bar	p.s.i.			
SSE1507	7	1.85	150	2175	1450	3 / 2.2	8.5
SSE1509	9	2.38	150	2175			
SSE1411	11	2.90	140	2030			
SSE1413	13	3.43	140	2030			
SSE1414	14	3.69	140	2030	1750	4.8 / 3.52	8.5
SSU1509	9	2.38	150	2175			
SSU1511	11	2.90	150	2175			
SSU1413	13	3.43	138	2000	15.2	4.7 / 3.45	
SSU1415	15.2	4.02	138	2000		5.5 / 4.04	

**OVERALL DIMENSIONS • ÄUSSERE ABMESSUNGEN • DIMENSIONS TOTALES  
DIMENSIONES TOTALES • DIMENSIONI D'INGOMBRO**

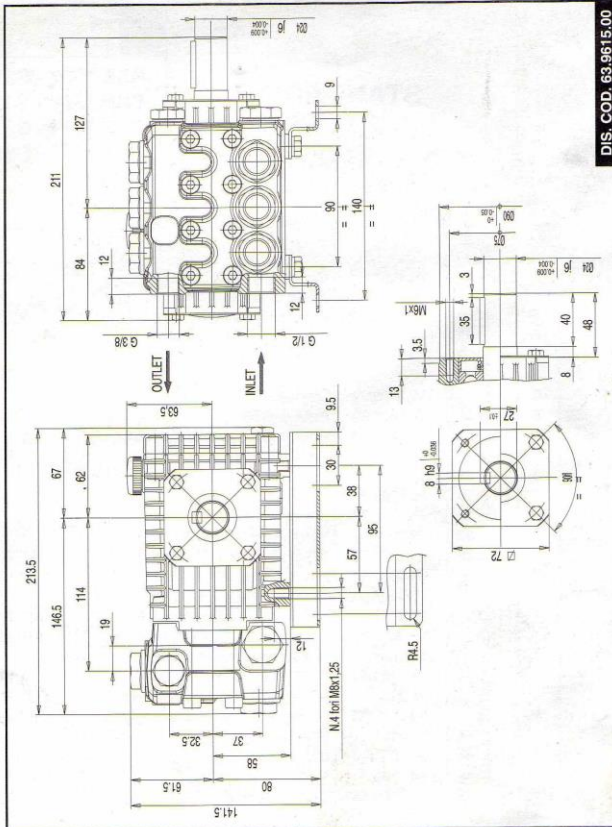

- **LUBRICATION:** Check the oil from time. Change the oil after 50 Hrs. operation and then after every 500 Hrs. We recommend INTERPUMP OIL X-9.9. (SAE 15W40 Mineral) - OIL CAPACITY 7 0.4
- **SCHMIERUNG:** Der Ölstand ist in regelmässigen Abständen zu kontrollieren. Der Ölwechsel muss nach den ersten 50 Arbeitsstunden, in der Folge alle 500 Stunden, vorgenommen werden. Es sollte INTERPUMP OL X-9.9 (SAE 15W40 Mineral) verwendet werden - Ölinhalt 0.4 l.
- **LUBRIFICATION:** Contrôler régulièrement le niveau d'huile. La première vidange doit être faite au bout de 50 heures maximum, ensuite faire une vidange toutes les 500 heures, on conseille huile INTERPUMP X-9.9. (SAE 15W40 Minerale) - CAPACITE D'HUILE 0.4 l.
- **LUBRIFICACIÓN:** Controlar periódicamente el nivel del aceite. El cambio del aceite, al comienzo, hay que hacerlo después de 50 horas de trabajo, luego cada 500 horas. Se aconseja aceite INTERPUMP X-9.9. (SAE 15W40 Mineral) - CAPACIDAD 0.4 l.
- **LUBRIFICAZIONE:** Controllare periodicamente il livello dell'olio. Il cambio dell'olio deve essere fatto inizialmente dopo 50 ore di lavoro, successivamente ogni 500 ore. Si consiglia olio INTERPUMP X-9.9. (SAE 15W40 Minerale) - CAPACITA OLIO 0.4 l.

**INTERPUMP GROUP**

VIA E. FERMI, 25  
42040 S. ILARIO - REGGIO EMILIA (ITALY)  
TEL. +39 - 0522 - 904311 • TELEFAX + 39 - 0522 - 904444  
E-mail: info@interpumpgroup.it  
http://www.interpumpgroup.it



Manufactures Literature

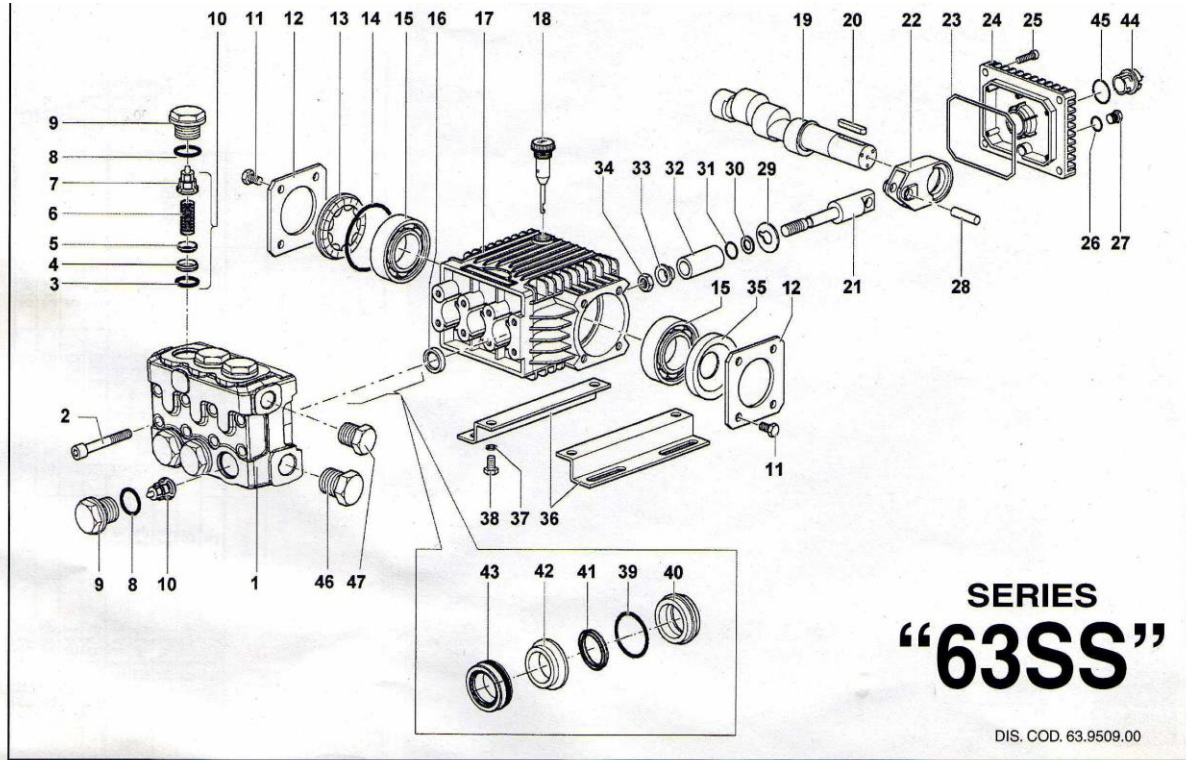

**SERIES**  
**“63SS”**

DIS. COD. 63.9509.00

KIT N.	PISTON - PISTONE Ø 15		PISTON - PISTONE Ø 18	
	KIT 159	KIT 192	KIT 214	KIT 215
Position included	16	3 - 4 - 5 6 - 7 (10)	41 - 43	39 - 40 41 - 42 43
Posizioni include				
N. pcs.	3	6	3	1















**STANDARD  
VERSION  
-M-**

MODEL - MODELLO:	
SSE1507 - SSE1509 SSU1509 - SSU1511	
SSE1411 - SSE1413 - SSE1414 SSU1413 - SSU1415	
KIT 204	KIT 216
41 - 43	39 - 40 41 - 42 43
3	1

POS.	CODE CODICE	DESCRIZIONE DESCRIZIONE	N. PCS.
1	63.1216.36	Testata pistone Ø 15 INOX	1
	63.1219.36	Testata pistone Ø 18 INOX	1
2	99.3193.00	Vite M 8x65 UNI 5931 INOX	8
3	90.3841.00	OR Ø 17,13x2,62 (3068)	KIT 192 6
4	36.2036.66	Sede valvola - SS	KIT 192 6
5	36.2001.76	Valvola	KIT 192 6
6	94.7373.00	Molla Ø m. 9,4x14,8 - SS	KIT 192 6
7	36.2025.51	Guida valvola	KIT 192 6
8	90.3847.00	OR Ø 20,24x2,62 (3081)	6
9	98.2229.00	Tappo M 24x1,5x17 INOX	6
10	36.7130.01	Gruppo valvola - SS	KIT 192 6
11	99.1808.00	Vite M 6x10 UNI 5739 - INOX	8
12	63.1500.76	Coperchio laterale carter - INOX	2
13	44.2118.01	Distanziale con indicatore	1
14	90.4097.00	OR Ø 55,56x3,53 (159)	1
15	91.8331.00	Cuscinetto a sfere 6305	2
16	90.1595.00	Anello radiale Ø 18x26x6	KIT 159 1
17	63.0100.22	Carter	1
18	98.2103.00	Tappo carico olio G 3/8	1
	63.0212.65	Albero SSE1507 - SSE1411 - SSU1509 - SSU1413	1
19	63.0216.65	Albero SSE1509 - SSE1413 - SSU1511 - SSU1415	1
	63.0218.65	Albero SSE1414	1
20	91.4892.00	Linguetta	1
21	63.0501.66	Guida pistone - SS	3
22	63.0300.22	Biella	3
23	90.3920.00	OR Ø 101,27x2,62 (3400)	1
24	63.1600.22	Coperchio posteriore carter	1
25	99.1838.00	Vite M 6x14 UNI 5931 - INOX	4

POS.	CODE CODICE	DESCRIZIONE DESCRIZIONE	N. PCS.
26	90.3585.00	OR Ø 10,82x1,78 (2043)	1
27	98.2040.00	Tappo G 1/4x9 - INOX	1
28	97.7335.00	Spinotto Ø 9x27,5	3
29	96.7076.00	Rosetta Ø 9x25x0,5 - INOX	3
30	90.5022.00	Anello antiest. Ø 6,2x9x1,5	3
31	90.3573.00	OR Ø 5,28x1,78 (2021)	3
	52.0400.09	Pistone Ø 15	3
32	44.0401.09	Pistone Ø 18	3
33	63.2115.66	Rosetta Ø 8 con collare - INOX	3
34	92.2215.00	Dado M 8 - SS	3
35	90.1641.00	Anello radiale Ø 25x62x10	1
36	50.2000.74	Piedino	2
37	96.7016.00	Rosetta Ø 8,4 UNI 1751 zincata	4
38	99.3037.00	Vite M 8x16 UNI 5739 - 8.8 zincata	4
39	90.3608.00	OR Ø 28,30x1,78 (2112)	KIT 215-216 3
	63.0806.66	Anello di fondo Ø 15 - SS	KIT 215 3
40	63.0807.66	Anello di fondo Ø 18 - SS	KIT 216 3
	90.2150.00	Anello ten. alt. Ø 15x19,5 L.P.	KIT 214-215 3
41	90.2200.00	Anello ten. alt. Ø 18x22,5 L.P.	KIT 204-216 3
42	63.2164.66	Anello intermedio Ø 15 - SS	KIT 215 3
	63.2165.66	Anello intermedio Ø 18 - SS	KIT 216 3
43	90.2160.00	Anello ten. alt. Ø 15x24x8,5 H.P.	KIT 214-215 3
	90.2210.00	Anello ten. alt. Ø 18x28x10 H.P.	KIT 204-216 3
44	63.2100.51	Spia livello olio	1
45	90.4051.00	OR Ø 26,58x3,53 (4106)	1
46	98.2180.00	Tappo G 1/2x10 INOX	1
47	98.2100.66	Tappo G 3/8x13 INOX	1

Manufactures Literature

 <b>CHART OF COMPATIBLE MINERAL OILS</b> VERTÄGLICHE MINERAL ÖLE MARQUES D'HUILES MINÉRALES COMPATIBLES TABELLA DEGLI OLI MINERALI COMPATIBILI	
INTERPUMP	 X-9.9 = ORIGINAL =
AGIP	 F1 SUPERMOTOR OIL
BP	 VISCO 2000
CASTROL	 GTX3 MAGNATEC
ESSO	 UNIFLO
FIAT (FL)	 VS MAX
FINA	 DELTA SUPER
IP	 AZZURRO
MOBIL	 SUPER
Q8	 Q8 FORMULA RALLYE
ROLOIL	 SUPERMULTIGRADE
SHELL	 HELIX SUPER
TEXACO	 HAVOLINE PREMIUM 15W40
TOTAL	 QUARTZ 4000

≡ SAE 15W40 ≡





- OIL VISCOSITY AT AMBIENT TEMPERATURES FROM +14°F TO +104°F
- ÖLVISKOSITÄT BEI RAUMTEMPERATUREN ZWISCHEN -10°C UND +40°C
- VISCOSITÉ HUILE A TEMPERATURES AMBIANTES ENTRE -10°C ET +40°C
- VISCOSITÀ OLIO CON TEMPERATURA AMBIENTE DA -10°C A +40°C

Cod. 91.0072.03 - 12/05 - 50.000 De Pietri

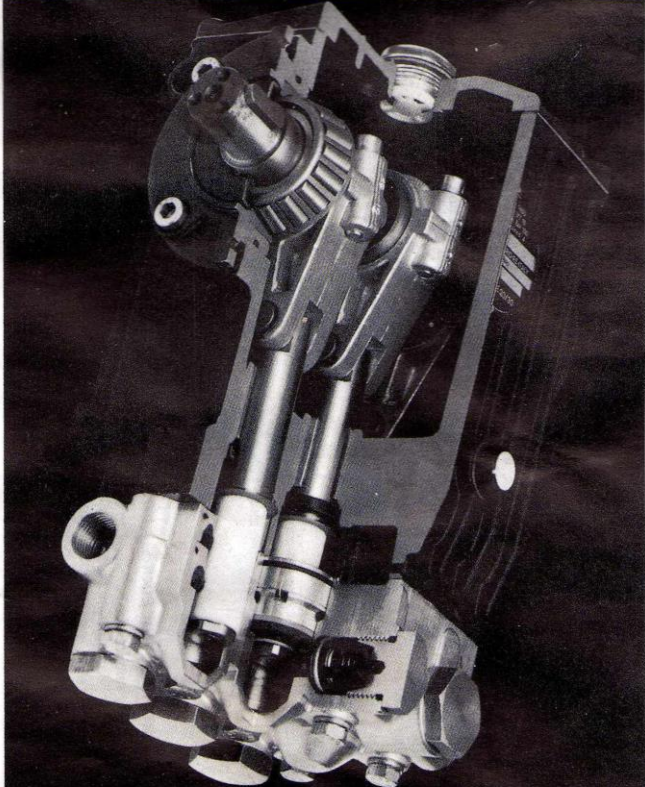
rev. 1

**OPERATING INSTRUCTIONS**  
 GERÄUCHSANWEISUNG  
 INSTRUCTIONS D'EMPLOI  
 LIBRETTO D'ISTRUZIONI



**...TWO IMAGES OF A WORLD-LEADER GROUP**  
 ...DUE IMMAGINI DI UN GRUPPO LEADER NEL MONDO

## **Logbook**

**Modell #** \_\_\_\_\_

**Manufactures date** \_\_\_\_\_

Sea water temperature

Pressure

Product flow

Salinity Sea water

Salinity product water

PH Sea water

## Quality Monitor (COMPACT and COMFORT Versions)

The Quality Monitor shows the quality of the product water in PPM TDS (Part per Million Total dissolved Solids)

When starting the system the quality is always for a short period ( 30-45sec) high salinity. Shortly the monitor starts to count down. As soon as the quality reaches the pre-set value(factory set point is 500PPM) the water is produced into the tank.

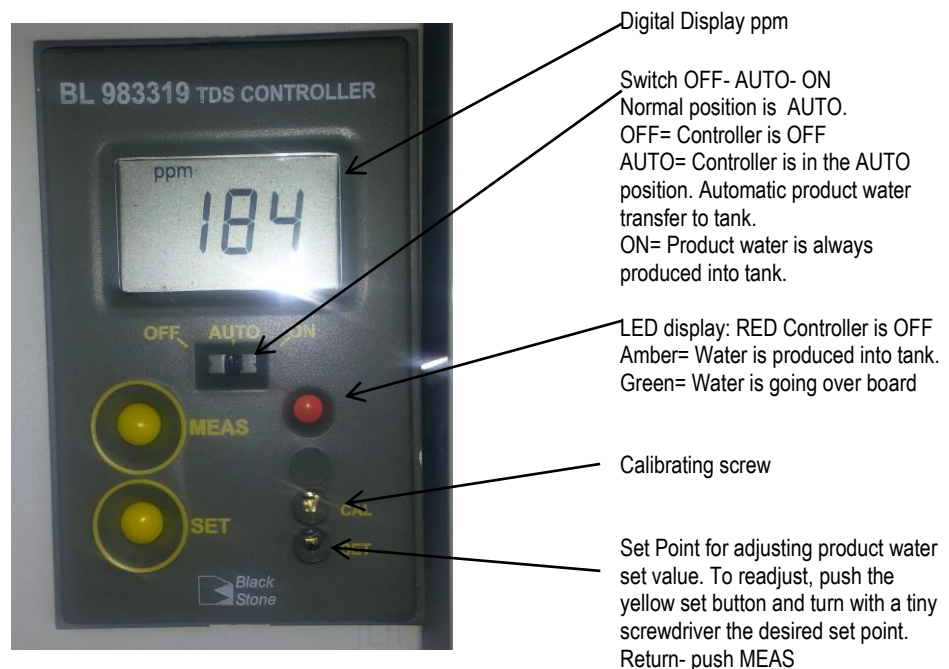

The controller is activating a diversion valve to control the destination of the product water. The diversion Valve is located at the right side of the Main control panel. There is an emergency gray button, to override the valve. Only to be used, when the controller is not working. Push and turn to the right to lock.

## The John Guest System

### How Super Speedfit Works

To make a connection, the tube is simply pushed in by hand; the unique patented John Guest collet locking system then holds the tube firmly in place without deforming it or restricting flow.

### Materials of construction

Super Speedfit fittings are made up of three components:

**Bodies** are produced in an acetal copolymer or polypropylene.

**'O' rings** are Nitrile rubber or EPDM.

**Collets** are produced in acetal copolymer or polypropylene with stainless steel teeth.

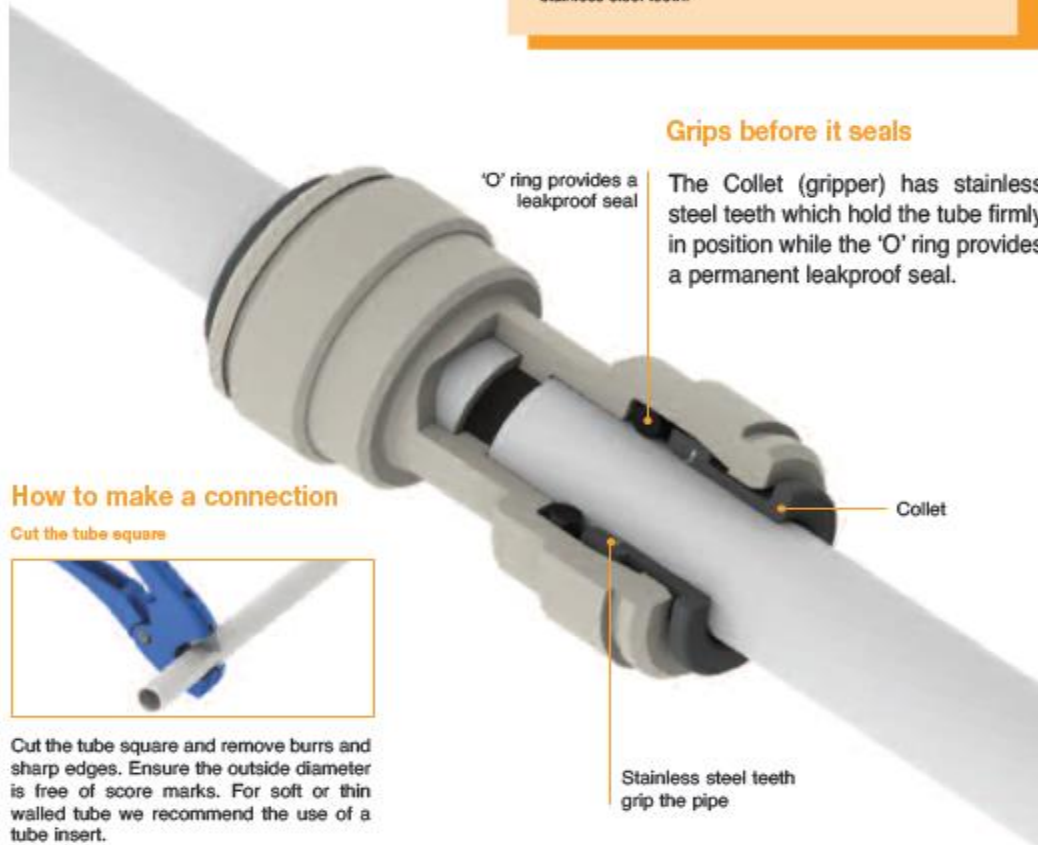

### Grips before it seals

The Collet (gripper) has stainless steel teeth which hold the tube firmly in position while the 'O' ring provides a permanent leakproof seal.

### How to make a connection

#### Cut the tube square



Cut the tube square and remove burrs and sharp edges. Ensure the outside diameter is free of score marks. For soft or thin walled tube we recommend the use of a tube insert.

#### Push up to tube stop



Push the tube into the fitting, to the tube stop.

#### Pull to check secure



Pull on the tube to check it is secure. Test the system before use.

### To disconnect

#### Push in collet and remove tube



To disconnect, ensure the system is depressurized, push the collet square against the fitting. With the collet held in this position the tube can be removed.

Wiring Version STANDARD

